

Specification Sheet

Élan-08R-720-Wi (Wireless VAV Omni-Directional Mixing)

Description

Élan-08R-720-Wi (Thermostatically Controlled Fully Wireless VAV Personal Comfort Diffuser) is a variable volume air terminal for use in raised floor air systems. It features an 18 gauge (1.3mm) galvanized steel catch pan assembly, with all interior features pre-painted flat black.

The nominal 8" (203mm) diameter cast aluminum grille produces 360 degree omni-directional mixing air flow. A manually adjustable sliding damper allows occupants to limit maximum air flow. Ten (10) standard grille colors are available; custom colors and finishes can be provided to match architectural design (specify on order).

The Élan-08R-720-Wi requires no wired connectivity of any kind to function. Power is provided by an integrated high capacity battery, designed to facilitate normal operation in an office application for up to ten (10) years (projected). Thermostatic control is handled via Zigbee 2.4 GHz wireless signal to a separate Concentrator. The Concentrator is connected to a standard 24 VAC zone controller, and accepts a 0–10V cooling signal. Each Concentrator supports up to thirty-two (32) paired units.

Features

- FCC approved 2.4 GHz wireless communications supports unobstructed zones up to 100 meters
- Connect up to 32 diffusers to a single wireless Concentrator (one Concentrator recommended per thermostatic zone)
- Sync units using the intuitive push-button pairing mode
- VAV damper designed for ultra low power consumption, providing a projected 10-year battery life
- Fully motorized diffuser plate moves in response to changes in temperature
- User-controlled manual damper for true personal comfort, independent of thermostatic control
- Parts and labor warranty covers 5 years of operation in a standard office application
- Ships fully assembled; quick, easy & efficient installation

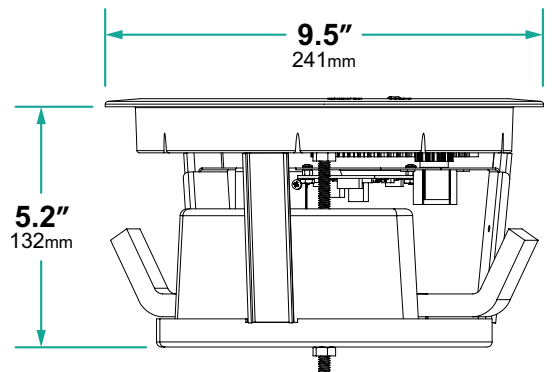
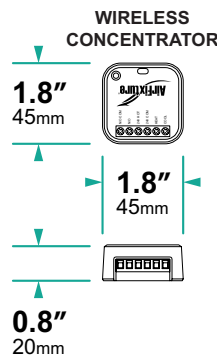
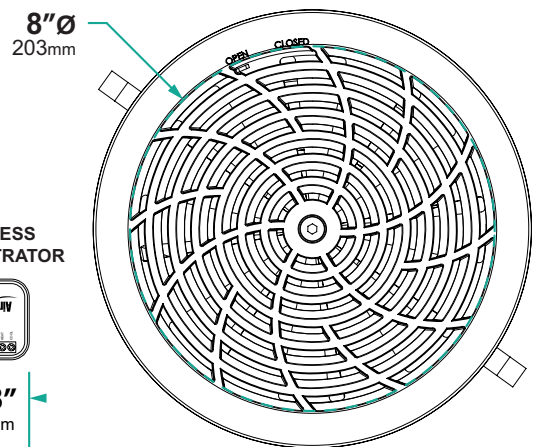

ALL DIMENSIONS NOMINAL +/- 0.1" (2.5mm)

Specification Sheet

Élan-08R-720-Wi (Wireless VAV Omni-Directional Mixing)

Alternate Diffuser Configurations



Uni-Directional
Desktop Mixing
(Élan-04R-180)



Uni-Directional
Displacement
(Élan-06R-180)



Uni-Directional
Mixing
(Élan-08R-180)



Omni-Directional
Mixing
(Élan-08R-360)

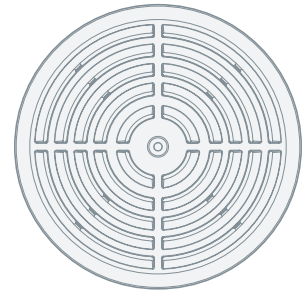

Omni-Directional
Displacement
(PDD-08R)



Omni-Directional
10" Mixing
(Élan-10R-360)

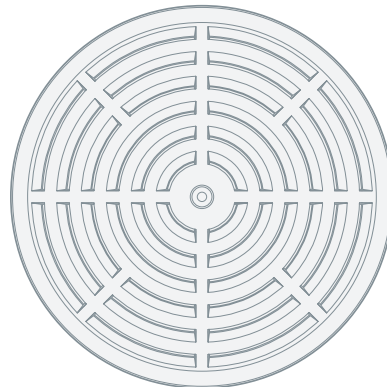

Omni-Directional
10" Displacement
(PDD-10R)

Specification Sheet

Élan-08R-720-Wi (Wireless VAV Omni-Directional Mixing)

Example System Layout

Cooling-Only with Fully Wireless Controls and Power

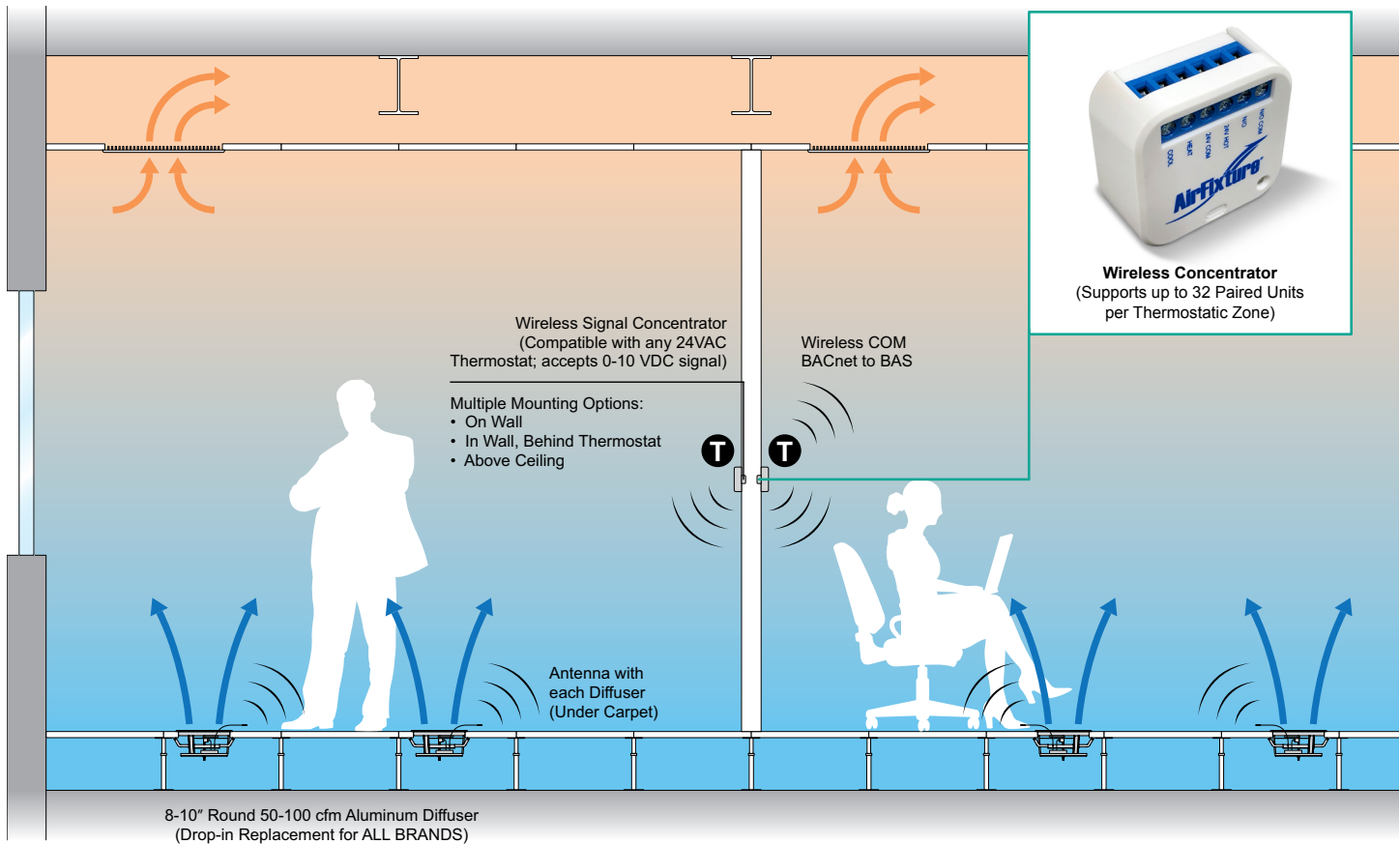

Specifications

Application:	Wireless Underfloor Cooling Raised Access Floors 6" (152mm) or Higher
Grille Dimensions:	Diffuser Opening: 8"Ø (203mm) Full Face: 9.5"Ø (241mm)
Diameter (Nominal)	Installation Cut-Out: 8.3125"Ø [+1.125/-0.00] (211mm [+3.175/-0.00])
Grille Rating:	Cast Aluminum Conforms to NFPA 90a 1250 lbs. (567 Kg) Load Strength
Supply Press. / Temp.:	0.02–0.1 in. w.c. (5–25 Pa) 40–140°F (4–60°C)
Capacity:	Maximum: 81 cfm @ 0.05 in. w.c. (138 m ³ /hr @ 12.5 Pa)
(Nominal)	Minimum (Damper Closed): 7 cfm @ 0.05 in. w.c. (12 m ³ /hr @ 12.5 Pa)
Noise Criterion:	≤ NC-17 (All Flow Conditions)
Battery Life:	Ten (10) Years (Based on Standard Office Application and Operation)
(Estimated Maximum)	
Wireless Signal:	2.4 GHz Zigbee (Maximum Thirty-Two (32) Units Supported per Zone Concentrator)